

0.079"(2.0mm) Box Header

Dual Row 06 to 68 Contacts

Straight And Right Angle Type Profile : 5.6mm

SPECIFICATION

Current Rating	: 3 Amp
Insulator Resistance	: 1000 Megohms min.
Contact Resistance	: 20 Milliohms Max.
Dielectric Withstanding	: AC 500 V
Operating Temperature	: -40°C ~ +105°C
Contact Material	: Phosphor Bronze or Brass
Insulator Material	: Polyester, UL 94V-0
	Standard : NY-6T
Contact Plated	: Full Gold, Full Tin, Selective Plated
Standard	: Gold Flash all Over Nickel

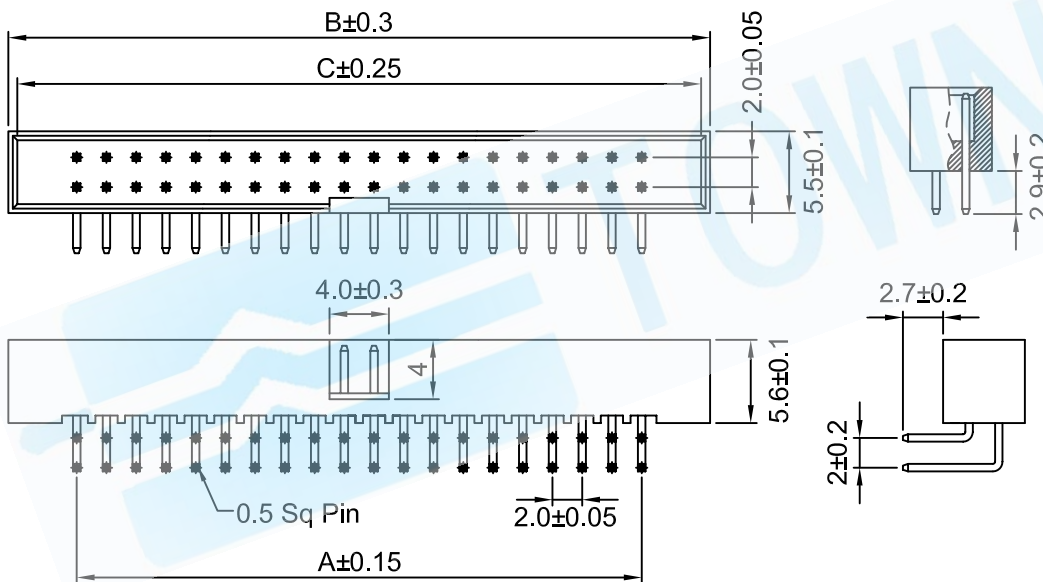
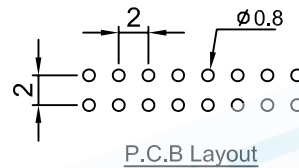
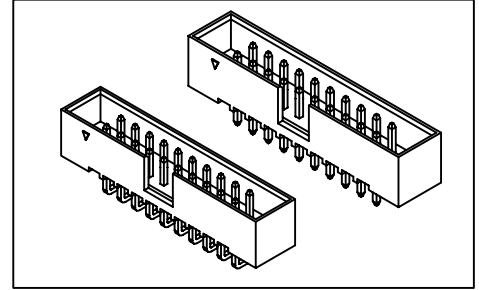

NO. OF CONTACTS	DIMENSION		
	A	B	C
6P	4.0	13.2	12.1
8P	6.0	15.2	14.1
10P	8.0	17.2	16.1
12P	10.0	19.2	18.1
14P	12.0	21.2	20.1
16P	14.0	23.2	22.1
18P	16.0	25.2	24.1
20P	18.0	27.2	26.1
22P	20.0	29.2	28.1
24P	22.0	31.2	30.1
26P	24.0	33.2	32.1
28P	26.0	35.2	34.1
30P	28.0	37.2	36.1
32P	30.0	39.2	38.1
34P	32.0	41.2	40.1
36P	34.0	43.2	42.1
38P	36.0	45.2	44.1
40P	38.0	47.2	46.1
44P	42.0	51.2	50.1
50P	48.0	57.2	56.1
54P	52.0	61.2	60.1
56P	54.0	63.2	62.1
60P	58.0	67.2	66.1
62P	60.0	69.2	68.1
64P	62.0	71.2	70.1
68P	66.0	75.2	74.1

HOW TO ORDER

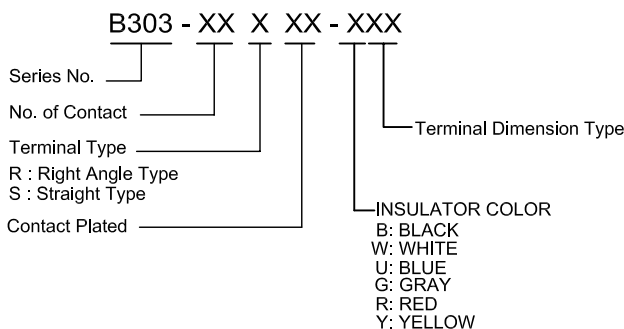

Full Gold Type	Selective Plated Type Gold Plated on Contact Area Tin Plated on Solder Area	Full Tin Type
GF : Gold Flash	HF : Gold Flash, Tin 100u"	T1 : Tin 100u"
G1 : Gold 3u"	H1 : Gold 3u", Tin 100u"	T2 : Tin 200u"
G2 : Gold 5u"	H2 : Gold 5u", Tin 100u"	
G3 : Gold 10u"	H3 : Gold 10u", Tin 100u"	
G4 : Gold 15u"	H4 : Gold 15u", Tin 100u"	
G5 : Gold 20u"	H5 : Gold 20u", Tin 100u"	
G6 : Gold 30u"	H6 : Gold 30u", Tin 100u"	