

0.079"(2.0mm) Female Header

Quad Row 12 to 120 Contacts

Straight Type Profile : 6.35mm

SPECIFICATION

Current Rating	: 1 Amp
Insulator Resistance	: 1000 Megohms min.
Contact Resistance	: 20 Milliohms Max.
Dielectric Withstanding	: AC 500 V
Operating Temperature	: -40°C ~ +105°C
Max Processing Temp	: 230°C For 30-60 Seconds (260°C For 10 Seconds)
Contact Material	: Phosphor Bronze
Insulator Material	: Polyester, UL 94V-0 Female Header : Nylon-6T(Standard) or L.C.P Pin Header : Nylon-6T
Contact Plated	: Full Gold, Full Tin, Selective Plated
Standard	: Gold Flash all Over Nickel

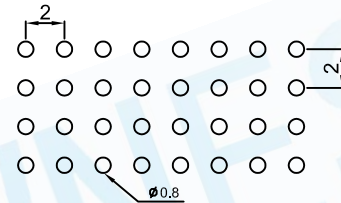
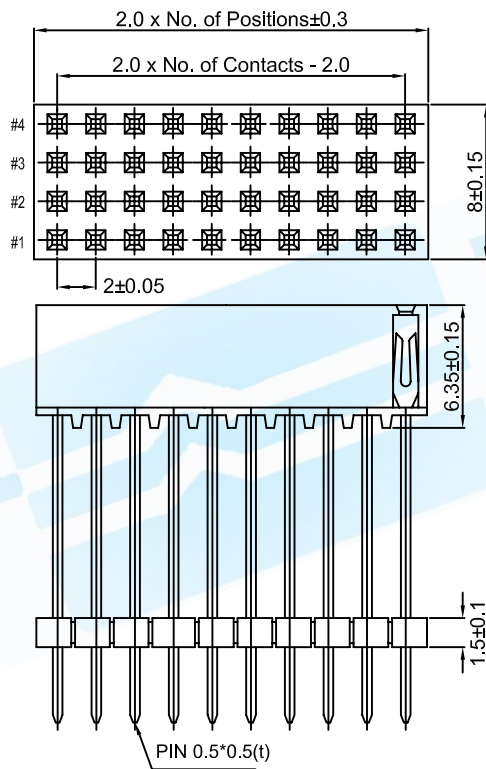
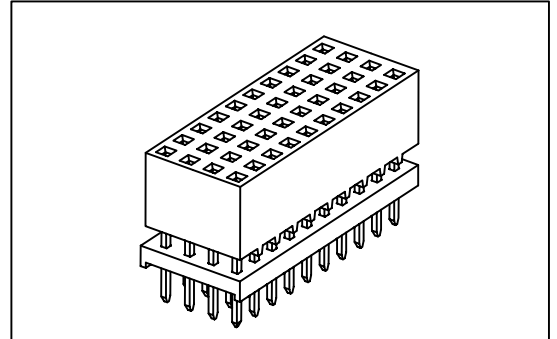

P.C.B. Layout

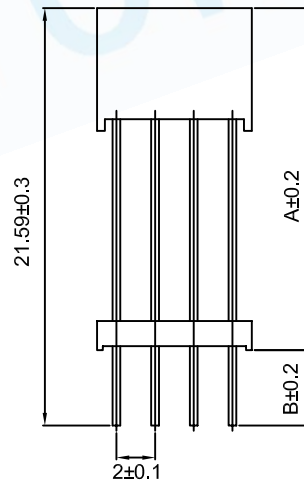

HOW TO ORDER

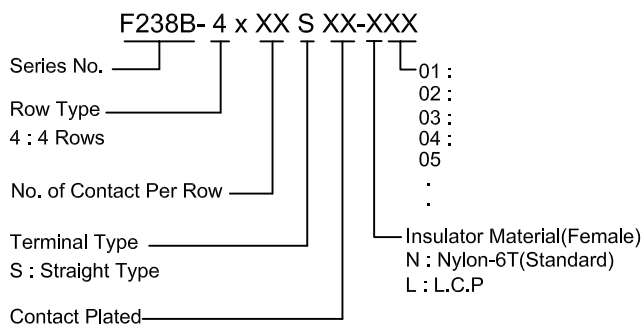

Full Gold Type	Selective Plated Type Gold Plated on Contact Area Tin Plated on Solder Area	Full Tin Type
GF : Gold Flash	HF : Gold Flash, Tin 100u"	T1 : Tin 100u"
G1 : Gold 3u"	H1 : Gold 3u", Tin 100u"	T2 : Tin 200u"
G2 : Gold 5u"	H2 : Gold 5u", Tin 100u"	
G3 : Gold 10u"	H3 : Gold 10u", Tin 100u"	
G4 : Gold 15u"	H4 : Gold 15u", Tin 100u"	
G5 : Gold 20u"	H5 : Gold 20u", Tin 100u"	
G6 : Gold 30u"	H6 : Gold 30u", Tin 100u"	